

# THE GARRETT SEARCHER

TREASURE SEARCH & ELECTRONIC RECOVERY

Fall 2002

  
**GARRETT**  
METAL DETECTORS  
Keeping It Simple™

## Garrett Unveils the Groundbreaking

## New Infinium LS

Metal Detectors

Lowest Prices, Free shipping

Many Gifts

www.detection.com

1-800-301-6151

It's here at last! Finally, demanding treasure hunters have a sensitive, deep-seeking detector that will not be stopped by even the most mineralized soil.

The totally new Infinium *LS* from Garrett overcomes the obstacle of excessive mineralization that has defeated even the most successful treasure hunters from the earliest days of the hobby. Modern technology now enables this new instrument to outperform any other metal detector in these treacherous areas.

Only the highly specialized Infinium *LS* can provide flawless performance under any conditions...in any soil...in any environment. Featuring Garrett's Advanced Pulse Induction (API) technology, the amazing Infinium will detect at new and greater depths while ignoring the highly mineralized soil that limits the operation of all other detectors.

Combined with Garrett's innovative new Power DD searchcoil, the Infinium *LS* has proved itself capable of

detecting nearly double the depth of conventional coils in mineralized soil. The new detector is submersible to depths of 200 feet for underwater hunting.

Years of research and development by the Garrett Engineering Laboratories has answered the demand of veteran THers to produce a detector that will find treasure virtually anywhere in the world, regardless of hunting conditions. The result is an awesome standard for detector stability, rigidity and performance power.

"Infinium" stands for the new instrument's infinite hunting abilities, and "LS" represents its land and sea applications. From deserted battlefields to sunken galleons, Garrett's new Infinium *LS* was successfully conceived to be the truly "go-anywhere" detector.

To achieve this level of sophistication Garrett engineers transformed the basic pulse induction commonly found in other detectors into a new, greatly enhanced circuitry technology called Advanced Pulse Induction. The hobby of treasure hunting with a metal detector will be hearing more from this technology.

The Automatic Ground Track allows "locking in" the ground track for optimum performance. In addition, "slow" or "fast" automatic tracking can be selected to insure proper ground balance no matter what detecting speed is chosen or how ground mineralization changes. Adjustable discrimination helps in hunting for desired targets and full discrimination is available at nearly 100% detection depth.

The Infinium *LS* is equipped with a 10 x 14-inch Power DD searchcoil. Mono searchcoils for use in areas with normal mineralization are available in 10 x 14-inch and 8-inch diameter sizes. All of these searchcoils are completely submersible and can be used under water.

Design of the Infinium *LS* enables the housing to be mounted in four different ways: above or below the stem, under the cuff or on the belt. The new detector is powered by eight AA batteries for 10-14 hours of use.



*The new Infinium LS finds treasure where conventional detectors suffer performance loss.*



*Steve Herschbach found these 13.5 and 3.8 Dwt gold nuggets with the Infinium LS.*



*The Infinium LS is a brilliant choice for underwater hunting.*

# Christmas Specials to Make Your Christmas Special

Save money on a great gift or upgrade your own metal detection capabilities to the industry's highest standards. These are only two of the choices behind the special money saving Christmas packages now being offered by Garrett.

The GTAx 550 and Treasure Ace 100 detectors featured in the packages are among the Company's less complex models. Each would make an excellent gift for a child, parent or spouse who wants to get started right in the metal detecting hobby. These detectors are ideal for that purpose because they offer the same Garrett quality and deepseeking capability as the Company's more expensive models. Rounding out the list of Christmas specials is the GTI 2500 Pro Package which is just what the name implies – the professional treasure hunter's choice – and offers an outstanding upgrading opportunity.

The Christmas Package accompanying the GTAx 550 includes a 4 1/2-inch searchcoil, offered at \$499.95. This price represents a savings of \$89.95 from usual retail prices.

The Christmas Package featuring the Treasure Ace 100 includes a set of Garrett headphones and a copy of Charles Garrett's highly popular *Treasure Hunting for Fun and Profit*, especially designed as a basic handbook for hunting with a metal detector, a treasure hunting guide for all hobbyists, but especially ideal for metal detecting novices. This package is offered at \$179.95, a savings of \$29.90 from usual retail prices.

The GTI 2500 Pro Package offers a fine opportunity to acquire Garrett's famed GTI 2500 imaging detector. The package includes 9 1/2-inch and 12 1/2-inch imaging searchcoils in addition to headphones and a large carry bag and is offered at \$1099.95, a savings of \$300 from usual retail prices.

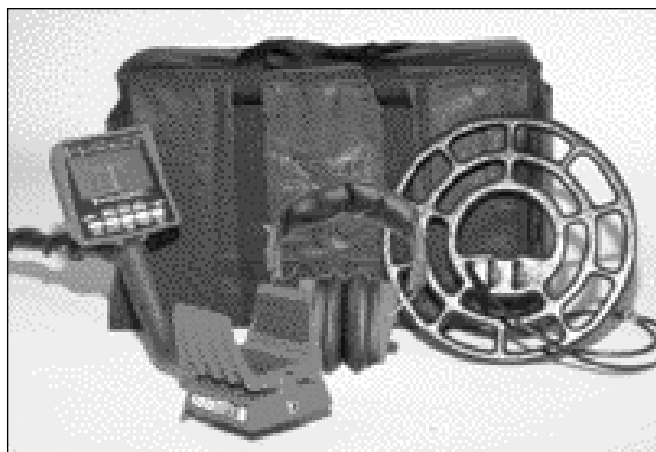

***GTI 2500 Pro Package***

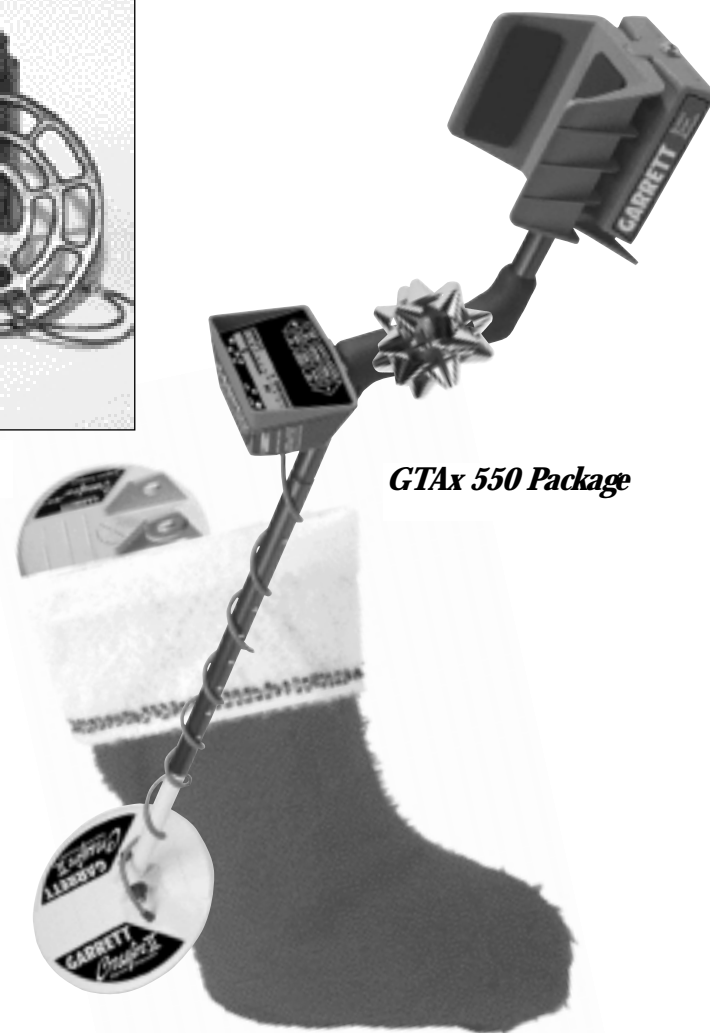

***GTAx 550 Package***

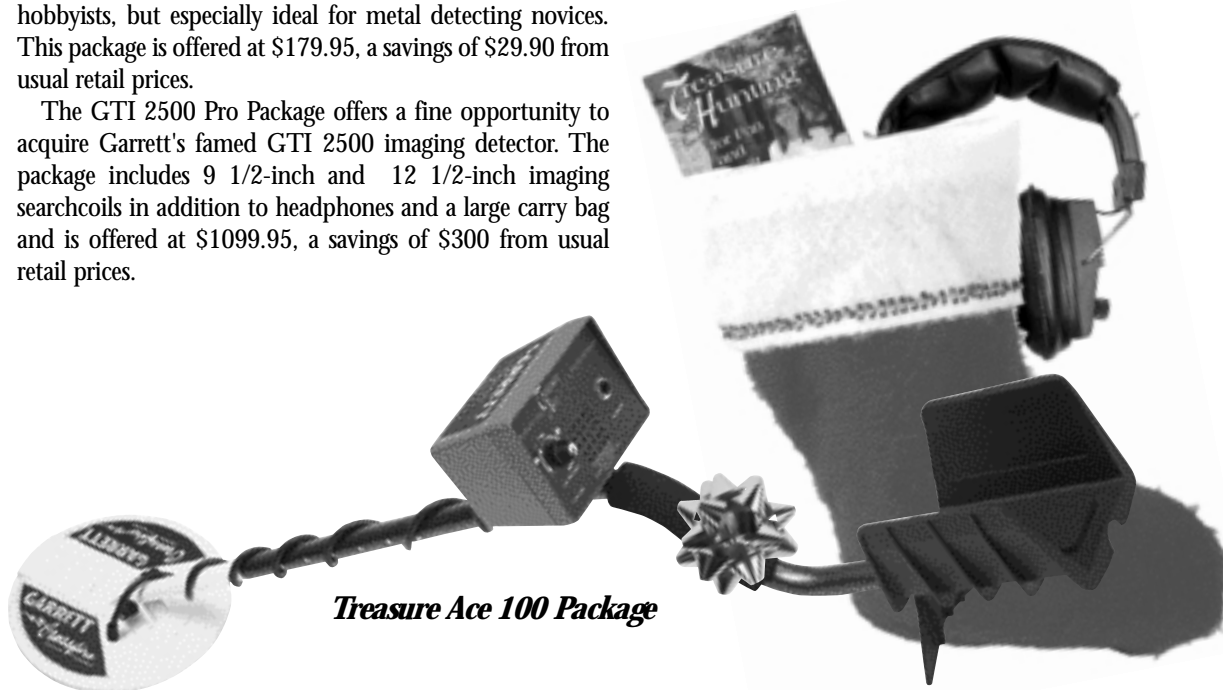

***Treasure Ace 100 Package***

## One Coin, Thousands of Dollars

**MAYS LANDING, NJ** – Daniel Hartman was surprised to learn that a coin he found with a Garrett detector a few years ago was much rarer than he thought. "I always figured it was scarce with only several thousand minted," he said, "but it turns out it is actually very rare, with only about 25 known."

The coin is a 1785 Vermont/Immune Columbia Copper (Ryder 1). Although worn and a little corroded, it is still very clearly identifiable. Because of its condition, Daniel had always figured that it "wasn't worth more than a few hundred dollars at the most."

Imagine his surprise when he sent photos of his find to

an expert on Colonial coinage who appeared to be quite excited about Daniel's discovery and estimated its value at auction of a few thousand dollars.

Daniel emphasizes that the coin is "not for sale," but he describes himself in shock nonetheless.

The coin was found with a Garrett Freedom III (original version) that he had borrowed when his Freedom Ace was acting up.

Daniel has used a number of Garrett detectors and now owns a GTAx 1000.



*Daniel Hartman's very rare coin find.*

# Charles Garrett and His Love of Metal Detecting

*This material was gathered for Lamar University, which is honoring Charles Garrett as a Distinguished Alumnus.*

By Charles Garrett

Garrett Electronics was founded by my wife Eleanor and me on two principles which continue to guide its growth:

1. Producing high quality products at a reasonable cost;
  2. Providing customer service second to none.
- She and I supplied the initial capital for the Company, and its growth since has been strictly a bootstrap operation. No outside investors have ever been utilized and bank borrowings have been limited to short-term situations.

I've always been a treasure hunter at heart. This fact is important in understanding the development of the Company. My electrical engineering talents enabled me to design my first metal detector when I grew discouraged by the operation of those already on the market. In continuing the development of this product and promoting its use, however, my love for treasure hunting was as important as my abilities as an engineer. I truly cared about the product, not just as an example of my engineering skills but as an instrument that could help me and others find more treasure.

Because of this love for treasure hunting, it was natural for me to take my detectors into the field and spend countless hours in learning how to use them more effectively. These efforts, which were absolutely "labors of love," were carried out all over the United States and in many foreign countries. It is truthful to state that I've discovered treasure on every continent except Antarctica. Of course, all these hours in the field greatly increased my treasure hunting ability and resulted regularly in the development of new and better products which produced steady growth for the Company. No new product was ever put on the market until I had tested it thoroughly under rigorous field conditions. Faithful customers knew and appreciated this fact.

For example, coins were the primary target of metal detectors when the first Garrett product reached the market. In my field testing I sought to learn detecting principles that would enable me and other hobbyists to find such other types of treasure as deeply buried caches and gold nuggets. Detectors for these specific uses were subsequently introduced, and were vigorously promoted. Thus, when the price of gold reached high levels in the 1970s, we were ready with detectors that had already proved they could find gold. The Company prospered.

I've always loved to talk about metal detectors and treasure hunting and have truly delighted in teaching others about their use. This has helped foster the development of the hobby of metal detecting and the growth of the Garrett Company.

They tell me that I'm by far the best known figure in the hobby of metal detecting. For more than 30 years I've been writing articles and books and conducting seminars on the use of metal detectors. I have given endlessly of my time. A competitor once told me that I was "his company's best

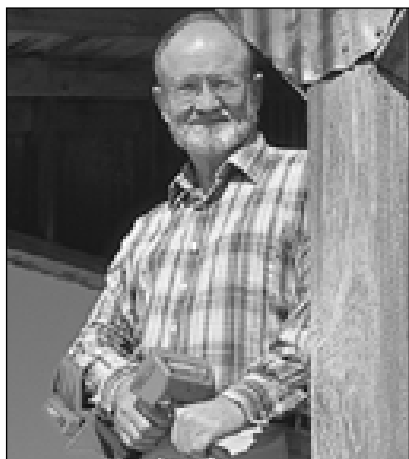

would "hunt deeper." Their products were generally inferior, and there was little or no factory support for them. In fact, many of the companies operated on a day-to-day existence.

Over the years all of us at Garrett Electronics have worked successfully to develop a true industry, converting the hap-

hazard hobby of hunting for treasure with a metal detector into almost a science. Certainly there were other companies operating when we entered the field, but our Company pioneered the scientific use of metal detectors for finding all types of buried and hidden treasures.

For the first two decades of its existence the Garrett Company was concerned almost entirely with developing and manufacturing metal detectors for treasure hunting, and we accumulated expertise and a considerable body of knowledge about the science of metal detecting.

In the early 1980s this expertise was focused on the field of security metal detectors, and Garrett's famed hand-held detector, the SuperScanner, was the initial result. It has been the pacesetter ever since and can be found in use today all over the world. It is probably safe to say that more SuperScanners have been produced than any other type of metal detecting instrument.

Next came Garrett's Magnascanner walk-through detector, whose initial uses were at the 1984 Los Angeles Olympic Games and the Republican Presidential Convention where President Reagan was renominated.

Incidentally, our detectors have been used quite successfully at every Olympic Games since, and we are already making plans for Athens, Greece, in 2004.

For the security industry Garrett once again provided extensive back-up support for its security products with books, videos and personal instruction in their effective use. In this field too, Garrett served as a pioneer in explaining and promoting the effective use of walk-through and hand-held detectors in a modern security system.

Thus, when the real "boom" in metal detector security hit in later years, Garrett was ready with high quality products and customer service second to none. The Company prospered.

salesman."

When we entered the metal detector "industry" some 40 years ago, it was far from being an established industry; there were literally scores of small companies, each claiming to produce a detector that

Over the years all of us at Garrett Electronics have worked successfully to develop a true industry, converting the hap-

hazard hobby of hunting for treasure with a metal detector into almost a science. Certainly there were other companies operating when we entered the field, but our Company pioneered the scientific use of

**"It is truthful to state that I've discovered treasure on every continent except Antarctica."**

# Stocking

# Stuffers



## Deluxe All-Purpose Convenience Bag

Model #1611500

Reg. \$29.95

**Now \$15.00**



## Coin Digging Kit

Includes Pouch, Probe and composite digger.

Model #1601070

Reg. \$21.95

**Now \$10.00**



## Texas Twister

Model #1618500

Reg. \$19.95

**Now \$5.00**

*While supplies last.*

## Environmental Covers

Model #1600400 CX

Model #1600371 GTax

or GTI 1500

Model #1618200 GTI 2500

Model #1619900 Treasure Ace

Reg. \$14.95

**Now \$5.00**



Garrett Metal Detectors • 1-800-527-4011  
1881 W. State Street • Garland, TX 75042  
www.garrett.com • sales@garrett.com

# Garrett Achieves ISO 9001:2000 Certification

Garrett quality, recognized for decades throughout the metal detecting industry, has been officially recognized on an international basis. Garrett has achieved certification as an ISO 9001:2000 Company by meeting stringent guidelines with regard to product design processes, manufacturing procedures, distribution systems and customer service methods for all products and services that Garrett provides.

ISO 9001 Certification is a guarantee to anyone, anywhere in the world that Garrett metal detectors come from a quality-managed organization.

Passing a rigid certification audit required that every member of Garrett's management, manufacturing and office staff work together to take an already existing set of quality systems to the next level. The quality level under which Garrett has been operating for nearly 40 years has been formulated into a clear and concise Quality Policy that every Garrett employee can proudly explain and execute.

This quality policy states that "Garrett Metal Detectors is committed to the design, production and distribution of products and services that enhance customer, employee and business partner performance, satisfaction and quality of life. We will pursue these goals with a quality management system that actively includes planning, implementation and review of policies and procedures to achieve continual improvement in operation of the company and its products and services."



*Garrett employees were treated to a "Fun Day" with lunch and recreational activities in the backyard of the Headquarters building after becoming ISO Certified.*

## France Honors Garrett's GTI 2500 as "Detector of the Decade"

The French have made it official: Garrett's GTI 2500 is "the detector of the decade." The prestigious French magazine *Tresor de l'Histoire* in its June/July issue cited the Garrett imaging detector as a "real revolution, saluted by all the pros in the field" and observed that "superiority of the electronics makes the decision unanimous. This detector is the best of the best."

In tracing the history of metal detection over the past 20 years the magazine noted that all manufacturers continually offer lots of promises each year with their new detectors. Yet all were described as simply "copying each other with the same traditional technology" and thus offering little real improvement.

The magazine saluted Garrett for the "long and hard work" that resulted in development of the Power Master Digital Signal Processor (DSP) chip, terming the result "incredible".

Testing of other detectors showed that a maximum depth of 10 to 12 inches could be achieved on a bronze Napoleon III coin (1-1/4 inch diameter) and a 10 x 14-inch steel box was detected at a maximum depth of 24 inches. With the GTI 2500, the magazine stated, "that same coin was now detectable at a good 16 inches, and the coin box at more than six feet. On a small gold wedding band we push the limit to 14 inches."

**"With this kind of detector everything is possible."**

Its conclusion was that "with this kind of detector everything is possible".

The article pointed out that the detector's searchcoil works in conjunction with graphic target imaging to "give you the edge" by revealing the actual size of each target with "full penetration and strength in all kinds of soil and better sensitivity on small non-ferrous targets".

The magazine article praises the GTI detectors as providing "all the adjustment you need. Five modes of search, adjustable frequency, sensitivity, volume, tone, threshold, automatic ground balance or manual, pinpointing, full notch discrimination, battery test and more and more..."

In conclusion, *Tresor de l'Histoire* states that "all of us who held the GTI 2500, 1500 or the GTAx 1250 in our hands came to the same conclusion. All those Garrett detectors are far ahead against the other high-end detectors of other manufacturers".

It's now official in France: "The real revolution and the detector of the decade is the Garrett GTI 2500".



*The GTI 2500*

# Garrett Helps Little Leaguers Concentrate On Their Game

**WILLIAMSPORT, PA** – The world's finest young baseball players were protected by the world's finest security metal detectors when the Little League World Series was held here this summer. Garrett MagnaScanners and SuperScanners were used to protect the athletes, their family members and other spectators.

The 25 walk-through and 50 hand-held detectors were operated by fully trained volunteers.

Stephen D. Keener, president and chief executive officer of Little League Baseball, said, "Garrett is the best in this business and we're grateful that a company of this stature would step forward in such a significant manner to help us".



*Spectators welcomed the new security to protect players, officials and fans.*



## Making a Good First Impression

### What to keep in mind when seeking permission to hunt on private property

by Jack Lowry

A common question among treasure hunters concerns obtaining permission to hunt when your travels take you to an interesting site that's just begging to be hunted. The stage is set for a wonderful outing, but you know that permission should always be sought from the landowner or a responsible tenant before you begin to search.

First, it is necessary to locate the owner or his agent. What next? Then comes what I refer to as the most important minute of the search. How you present yourself in this first moment will have a great bearing on the success or failure of your endeavors. Remember too that – like it or not – you always represent the entire metal detecting community. What you say and do, and how you present yourself speaks for and about all of us.

Because you value your time, it's easy to understand how the property owner values his. Don't pound on some stranger's door at 8 a.m. or at 8 p.m. Wait at least until 9 a.m. and don't pound after 6:30 or 7 p.m.

Only one person should seek to speak to the property owner. The door may never open if there is a gang on the porch. Common courtesy dictates that after ringing the doorbell or knocking, you take at least two steps away from the door. Don't crowd the private space until invited to do so.

But, before you knock, look in a mirror. Do you see someone you might invite into your own home? Always be presentable. Don't wear torn, ragged or filthy clothes. A decent shirt is a must and T-shirts of questionable size or subject matter are one of the first things a stranger sees. For the ladies, this means that modest apparel is a must.

When the door opens, the property owner first judges your appearance. Is your hair combed; are you neatly groomed and clean; are you hiding behind sunglasses and a cap? Look as good as possible. Also, don't go to the door decked out for digging. Many people have no idea what to expect, and a large digging tool or pouch can conceal a lot from view. There may be a reluctance to speak (or, open the door) if a large knife is present. Plus, your detector could

close off an otherwise positive opportunity.

Don't even think of smoking or chewing on the premises, now or later. What you may do at home should not even be considered at the home of a stranger.

Practice what you wish to say before arriving at the location. Be prepared and be brief. Say only what needs to be said: who you are, what you would like to do and some indication of your expertise. Don't hesitate to give references. Offer them; don't wait to be asked. Remember, although you are asking permission to utilize your skills and further your hobby, the property owner can be expected to have absolutely no interest in your desires.

The property owner really has only two responses: yes or no. Always remember that if the terms of his agreement are beyond reason, or more strict than you are willing to accept, you also have the right to say no.

---

**“Permission should always be sought from the landowner before you begin your search.”**

---

If he says "no," there is little choice in your actions. Depart immediately and don't come back at night or when you know the property is deserted. That is called "trespassing," and if you survive, criminal charges can be lodged against you.

We've all heard stories of a promising site lost because permission was not granted. Generally, these instances are followed by claims or thoughts that the owner surmised that you were more aware of the early history of the property than he and, therefore, knew of something valuable hidden there. Thus, he might want a friend to search the property, knowing that anything found would be turned over to him. He might even decide to search for himself. Imaginations can be vivid and often run amok.

After you receive a "no" answer, politely thank the owner

for his time, leave a card and ask that should he reconsider or circumstances change, he give you the opportunity to return and to discuss the site search. This probably won't happen, but I have had sites reopened by those who said no previously because my partners and/or I did as we said we would with neighbors and business associates.

The "yes" reply opens the door to communication, discussion and is a negotiation in a sense. Let the landowner use his input for the grounds of negotiation to determine what he might expect to be found. You may wish to offer to prepare or complete a search agreement. Preprinted forms are available and they usually contain space for setting out specific items which, if found, must be returned to the property owner (or tenant). These items should always be discussed in advance. The monetary worth of coins, caches and other items of value is generally split 50-50. Evaluations and

appraisals may be necessary and those costs are split as well. Anything not detailed on the agreement is subject to this agreed-upon split. But, all items that are discovered should be shown to the landowner as a courtesy.

A hand-written agreement may look to be less professional, but that may not be all bad. A preprinted or computer-generated form could indicate to the landowner that you

know of a large or valuable treasure of which he may not be aware. This could lead to a difficult negotiation and/or a situation that leaves you in an untenable position.

I know that all of this sounds "iffy" but I have found it to be not much of a problem. No problem that is, if a signed search agreement results. Such an agreement should always be completed before the hunting begins, since this also serves as your permission to search.

Remember that only two answers can be given by the landowner, and a "no" makes all this a moot point. The question becomes how well you present yourself in this most important minute of the search.

CHRISTMAS COMES BUT ONCE A YEAR,  
JUST LIKE THESE SPECIALS.



## GTI 2500 PRO PACKAGE

GTI 2500 Pro Package at the price  
of the standard GTI 2500 detector.

Includes: GTI 2500 Detector, 9.5-inch and 12.5-inch imaging coils,  
Garrett headphones, and the Supreme GTI case, \$1099.95

You Save \$300.00

#1120581

# GTAx 550



## GTAx 550 Package

Includes: GtAx 550 Detector and  
4.5-inch Crossfire II Searchcoil

\$499.95

You save \$89.95

#1151850

# TREASURE ACE 100



## Treasure Ace 100 Package

Includes: Treasure Ace 100 Detector, Headphones and  
Book - *Treasure Hunting for Fun and Profit* by Charles Garrett

\$179.95

You Save \$39.90

#1131050

Prices available October 1, 2002 through December 31, 2002. Available at participating Garrett Authorized Dealers.



Garrett Metal Detectors • 1-800-527-4011  
1881 W. State Street • Garland, TX 75042  
www.garrett.com • sales@garrett.com



Copyright ©2002 Garrett Metal Detectors. All Rights Reserved.

# Finding A Deer and Something Dear With a Garrett

**BUFFALO, NY** – Good news and bad news accompanied Richard Kwiatkowski's deer hunt last winter. The good news was that he got his spiked buck. The bad news was that he lost his wedding band in the process. Garrett to the rescue!

Richard reports that on the second day of deer season last winter he hunted through a light cover of snow and bagged his buck. "While field dressing the deer," he said, "I periodically cleansed my hands by scooping up some snow and rubbing them back and forth. While doing so, my wedding band slipped off my finger and was lost in a heavy ground cover of leaves beneath the snow."

In his excitement over shooting the deer, Richard didn't miss the wedding band until the following morning. Greatly upset, he searched the hunters' cabin thoroughly and finally realized that he had lost the ring at the field-dressing site. He immediately returned to this location and spent hours poking through the leaves.

"It was like looking for a needle in a haystack," he said. "So, I returned home for Thanksgiving but said nothing to my wife about the lost ring."

Richard spent the next two days back at his hunting camp searching in vain before realizing that only a metal detector might save him. Garrett dealer Nicholas Laratondo supplied a Treasure Ace 300 and enough instruction to send Richard back out into the field.

In searching the area where he field-dressed the deer, he found lots of scrap metal but no ring. Expanding his search, he eventually located the wedding band some distance away and surmised that he might have moved it himself in his futile searching.

"It was unbelievable," he states, "and my jubilation was profound. I am very appreciative of Nick Laratondo and the capability of his Garrett metal detector."

# Treasure Ace 300 Restores Faith

*Ernie Rosenbaum of Rosenberg, Texas, has written to Charles Garrett to tell of his complete satisfaction with a new Treasure Ace 300.*

"I have owned a few different metal detectors," he stated. "The last was a (competitive model) that was continually going off on everything, and I decided to just give up metal detecting."

Instead, he decided to upgrade to a Garrett. A coin collector since 1965, he chose the Treasure Ace 300 since it specializes in locating coins.

"My first trip out I found about 37 coins," he reported. "I came home and was reading the book that came with the detector written by Mr. Garrett and came across a passage that said the average coin hunter can average up to 7000 coins per year. I found that hard to believe, but, in about 15 or so two-hour searches I have already found over 700 coins."

"I want you to know how pleased I am with the Treasure Ace 300. Thanks for restoring my faith in metal detectors."

# After Nearly 30 Years, A Ring Finds Its Way Home

**MILLBURY, OH** – The marriage of two technologies finally resulted in another success story for the treasure hunting fraternity, but there was a wait of nearly 20 years in how the story played itself out.

Garrett's detector technology enabled Tom Boyd to find a college class ring at a campground at Michigan's Silver Lake State Park in 1991. It was a 1968 ring from Michigan Technological University, a school based in Houghton, MI. The 10-karat gold ring with an onyx stone was engraved "PRP" and was buried under about six inches of sand.

This could have been the end of the story except for the advent of computer technology when the Boyds purchased their first computer earlier this year.

Tom was a true computer novice but at Mrs. Boyd's urging, he found the MTU website and clicked his way to the alumni link and found that Phil Patana of St. Louis was a member of the class of 1968 and that he had indeed lost his class ring in 1973.

When he received his ring Mr. Patana said, "The fact they took the time and effort to locate me, rather than take a quick trip to the pawn shop, speaks volumes about their character."

# Great Buys on Great Books!



## Coin Hunting Package

Model #1508900  
A \$19.90 Value  
*New Successful Coin Hunting*  
*The Competitive Treasure Hunt*  
Both books for \$10 plus \$1 shipping

## Jennifer and Robert Marx

Model #1509000  
A \$19.90 Value  
*Gold of the Americas*  
*Sunken Treasure: How to Find It*  
Both books for \$10 plus \$1 shipping

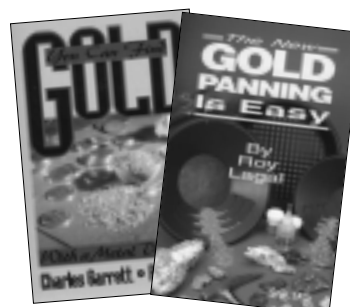

## Gold Hunting Package

Model #1509100  
A \$19.95 Value  
*Find Gold with a Metal Detector*  
*Gold Panning is Easy*  
Both books for \$10 plus \$1 shipping



Garrett Metal Detectors • 1-800-527-4011  
1881 W. State Street • Garland, TX 75042  
www.garrett.com • sales@garrett.com



Copyright ©2002 Garrett Metal Detectors. All Rights Reserved.



# THE MASTER OF MINERALIZED GROUND, WHEREVER IT OCCURS.



Experience the most stable, rigid and performance-packed detector available today, the new Garrett Infinium *LS*, featuring Advanced Pulse Induction (API) technology, a convergence of the latest metal detection technologies.

The Infinium *LS* ("L" for Land, "S" for Sea) features superior depth, exceptional sensitivity and

discrimination while finding relics and gold in areas where conventional detectors suffer performance loss.

Call Garrett today at 1-800-527-4011 for more information on the new Infinium *LS*, or visit our website at [www.garrett.com](http://www.garrett.com).

\*Underwater headphones required for diving.

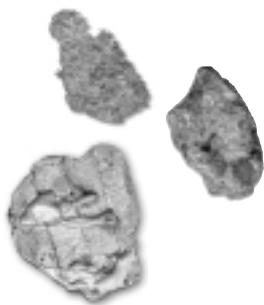

#1152070 Infinium *LS*, \$1250.00;  
Includes 10" x 14" Power DD Coil,  
rechargeable batteries and rechargers.

#2216900 10" x 14" Mono Coil, \$149.95  
#2217000 8" Mono Coil, \$129.95



Garrett Metal Detectors • 1-800-527-4011  
1881 W. State Street • Garland, TX 75042  
[www.garrett.com](http://www.garrett.com) • [sales@garrett.com](mailto:sales@garrett.com)



# Tree Farming and Metal Detecting, Garrett Style

*Charles and Eleanor Garrett have received a double honor from the Texas Tree Farmers Association. They were selected as Tree Farmers of the Year for 2002 and also named as Life Members of the Association. Following are excerpts from an article that appeared in the July issue of Texas Forestry, the organization's publication.*

Every now and then someone comes along who reminds you that by working hard, doing your best, keeping your word and thanking a friend, life will be better for you as well as those who surround you. For TFA, Charles and Eleanor Garrett came along and became the 48th Life Members in the Association.

They live in the Dallas suburb of Garland and are the owners of Garrett Metal Detectors, the world's largest manufacturer of metal detection equipment. Their products are used by hobbyists and for security. Started in 1964, their company has provided security for airlines, schools and numerous other facilities.



*Charles & Eleanor Garrett*

Charles and Eleanor Garrett are also Tree Farmers, owning many tracts of land in Trinity and Houston Counties. Earlier this year, they were named the 2002 Outstanding Tree Farmers for Texas. "They are both enthusiastic about the management of their property and are considering building a home on their pine tree timberland," said Richard Cole, a forester with Louisiana-Pacific Corporation, who assisted them for many years. In directing their Tree Farm activities, the Garretts work closely with Tom Crater Professional Foresters Group. Since the beginning of their tree farm activities in 1975, the Garretts have relied heavily on the Texas Forest Service tree farmer program in managing their property.

Eleanor is the one who first thought it prudent to grow trees. She and Charles bought much of their timberlands from Eleanor's relatives or close friends of her parents. "When anyone in the family decided to sell their land, they would call me and we would borrow the money to pay for it and then pay back the loan," Eleanor said. All their land is located in the vicinity of Pennington where Eleanor grew up. In fact, Eleanor calls the different tracts of land by the names of the folks she bought them from. There's the Gibson tract, the English tract, the Taylor place, the Gandy place, etc. Eleanor tells the story of buying land the East Texas Way of Long Ago. Years ago, she received an envelope in the mail and found it to contain a deed to 50 acres in Trinity County. The deed was signed by a gentleman who had been a friend of her father. Several days later, Eleanor went to see him and paid him for the 50 acres. It never occurred to this gentleman that she would not pay for the land. She now calls this the Holmes tract.

Eleanor lived in Lufkin through 5th grade where her father, Mervin Smith, was an elementary principal. Her family then moved to Pennington where her father became the superintendent and her mother, Hazel Marie Gibson Smith, was a substitute teacher. Eleanor graduated from Pennington High School and attended Sam Houston State University where she earned both a Bachelors degree and Masters degree in education. She is a member of several organizations including the Daughters of the American Revolution, Magna Carta Dames & Barons, Eastern Star and many others. Eleanor is also a history buff. "When I was young, my daddy taught history for several years before he went into administration. My father's bedtime stories were about Sam Houston and Daniel Boone, and my mother told me about Little Red Riding Hood," Eleanor said. Eleanor has been a lifelong member of the Baptist Church and currently attends Orchard Hills Baptist Church in Garland.

At the County Fairgrounds in 1950 (located where the Lufkin Middle School now stands), Eleanor Smith met

Charles Garrett when he asked if he could "help you with those ducks?" (Eleanor was carrying ducks her teacher had won to the school bus). "I always say the reason she let me carry the ducks was because I was wearing my National Guard uniform," Charles said. The uniform included a green scarf, which Charles gave to Eleanor. They were married June 30, 1955 at the Pennington Baptist Church and Eleanor still has the green scarf today. They have two sons and one daughter.

Charles grew up in Lufkin. His parents, Wayne and Stella Barber Garrett, operated Household Furniture Co., on North Main Street during the WW II period. They later opened Garrett Upholstery and Carpet Co., which they operated until they retired in the 1970s. Charles has been a member of the Church of

Christ since age 13 and currently attends the Saturn Road Church of Christ. After graduating from Lufkin High, Charles enrolled at Stephen F. Austin State University to pursue a degree in forestry. The Korean War interrupted college for Charles when he went to serve as an electrician's mate in the U.S. Navy. After his discharge, Charles enrolled at Lamar University and graduated in 1959 with a bachelors degree in electrical engineering. He then moved his family to Garland to begin his long career in electronics. His first job was with Texas Instruments in Dallas, and he later joined Teledyne Geotech in Garland.

For two years Charles worked in his garage at night developing metal detectors while working full-time during the day for Geotech. On April 1, 1964, Charles and Eleanor founded Garrett Metal Detectors, but Charles kept working for Geotech on a part-time basis until their company was off the ground. Eleanor had quit teaching by that time, and she managed all clerical, accounting and promotional activities for their company. Both Charles and Eleanor knew that marketing was essential if their business was to be successful and they worked diligently in this effort.

They attribute their success to the guidelines they set for themselves over 38 years ago: Building the best possible product they can build and giving the customer the best possible service.

The Garretts are gracious people with discernible minds and generous hearts. They originally joined TFA in 1998 and thought it prudent to become Life Members this year. TFA is honored to have Charles and Eleanor Garrett as its newest Life Members.

---

**“Building the best possible product they can build and giving the customer the best possible service”**

---



# The "Magic" of Detecting With a Garrett

By Ned Carl

Magic! After turning on a Garrett GTAx 750, that was my first thought.

Wow! Things have changed since my first detector back in the early 70s, which I still have – a (competitive model) "Mustang."

I became re-interested in the art after a friend dropped off an ad for a metal detector distributor. I then spent weeks doing research on the Internet and calling every retailer, wholesaler and distributor I could get in touch with. The name Garrett popped up in nearly every conversation. After settling on a Garrett, then I spent more time combing literature until I decided on the GTAx series and further, the 750.

Since I purchased the GTAx just a year or so ago, I guess you can call me a "new" beginner!

When it arrived, I opened `er up, assembled it, then spent the remaining days until the weekend, reading the manual. The features were, and still are, mind boggling. Saturday morning rolled around, and just as a trial run, I walked out to the back of my property, along the edge of a creek. My neighbor, who had seen me, said, "You won't find much, this used to be a horse pasture."

Well, I tried anyway. Within just a few feet of scanning, I hit a strong signal. I dug up a 1925 "Mercury" dime. My very first find was a silver coin. I was absolutely stunned. The next day, in my front yard, near the sidewalk, my daughter and I brought up a 1936 silver quarter. Now I knew it was magic. No other explanation was feasible.

Since that first day, I have found 642 coins, along with numerous toy cars and cap gun parts from eras gone by, bullets, ammo casings, old glass lined "Ball" lids, a bracelet, a few rings and earrings, a pocket knife, house keys, a Boy Scout neck tie clasp, canine dog tags and a military dog tag I traced back to 1947.

Oh, say, did I mention I've been a coin collector since I

was 12 years old or so? Well, the "magic" continues. Early this year I ordered 3 of your books, to help enhance my knowledge of this new era of metal detecting. I had read about halfway through *New Successful Coin Hunting*, and had just finished the story about the 300 Colorado tax tokens, when that very weekend I went out–voila!–I found an Alabama luxury tax token, and another silver quarter. More Magic. I get all shaky just talkin' about it! I'm in the process of doing some Civil War "studies" now, you know...expanding my horizons.

I moved to Alabama from Nebraska in 1984, mostly to follow my true love of fishing. I've been in a few fishing clubs, and even started one here at work. The problem now is, my time gets split between detecting and fishing, so my partner is quite concerned I may leave him "stranded" in the water.

Being a fisherman/outdoorsy type has helped me devise a routine to insure that I search every nook and cranny of an area. I took two large, steel tent spikes, attached a key ring with a metal clasp to one. To the other, I mounted an old baitcasting type fishing reel, (with hose clamps and a piece of rubber fuel line). On the reel I have 100 feet of 30 pound fluorescent (easy to see in the grassy areas) fishing line, with a key ring on the end of the line. I can now easily mark off 100 X 4-1/2 feet areas to scan. Why 4-1/2 feet? Well, I measured my average "swing path" at around 5 to 5-1/2 feet, so I cut it down to 4-1/2 feet, to be able to overlap with each pass.

I then devised a "belt" on which I have a rappelling "D" clip, two garden trowels hang on that. On the opposite side of the belt I have a "Quiver" in which I carry 15 dayglo orange construction marker flags, 10 green flags and a long shaft screwdriver. On the front of my quiver is another pouch, with a velcro flap. This pouch is just big enough to hold a quarter sized plastic coin tube. In the coin tube is a small foam plug, that keeps the coins from bouncing around.

Now I can mark off an area, flag each "hot spot", then when I run out of flags, start digging, (if my wife or daughter aren't already involved).

As if the Coins mode on the GTA isn't fantastic enough, with its nearly total discrimination of junk items, I have become quite familiar with the Custom mode. Being a collector of American coins for many years, I have always been intrigued by the "Buffalo" nickel; it has always been my favorite coin.

So, with that in mind, I used a more modern "Jefferson" nickel and an early "Buffalo" nickel in my yard and did a battery of tests, with the coins laying flat, standing on edge, even tried a few angled passes, then created my personal "Nickel" mode. So now, after I scan an area I have marked, I go BACK over it, scanning for nickels I may have passed up as trash in my initial run. This is what the green marker flags are for; in this way I can note the difference between what I found in regular coin mode, and what I find in Custom mode.

I have yet to find a Buffalo nickel, but I will, I have no doubt in my mind.

I'm sure there are many folks out there who tried metal detecting 10, 20 or as in my case, even 30 years ago, and gave it up because their old machine kept producing trash. These people have no idea how easy the hobby has become with the advent of computerized circuitry. It is my aim to, as Cab Calloway put it in *The Blues Brothers*... "Put the word in the street".

Although I have had only the GTAx 750 in my hands, I can see that Garrett designs and manufactures other fantastic equipment, and I thank Garrett for re-introducing me to a fabulous hobby. Working in the telecommunications industry has taught me well what microprocessors plus digital circuitry can do for all things electronic, and the Garrett Company puts this knowledge to great use. Keep up the great work, and thanks a million.

## Infinium LS, A New Product For Finding Old Treasure

Garrett's new Infinium LS will help any treasure hunter who tries to search in the heavily mineralized soil found in so many locations throughout the world. The new detector will be especially beneficial to prospectors and cache and relic hunters.

Prospectors have been in special need of this new instrument since gold-bearing ground over which they search always has a greater degree of mineralization than is normally found elsewhere. Prospectors now have a deep-seeking detector that will accurately find gold in spite of the other minerals and will provide discrimination to nearly 100% of detection depth. The Infinium LS will find tiny nuggets that other detectors miss while ignoring hot rocks, salt, terra cotta and overall changing ground conditions.

It has also been the experience of many cache hunters that the treasures they seek, especially in the American

Northwest, are hidden in ground with a high degree of mineralization. Because of these excessive minerals, cache hunters have been disappointed with detector performance. Relic hunters too will benefit from the technological advantages of the Infinium LS because many Civil War battles were fought over mineralized soil that can baffle the circuitry of detectors that lack the superior technology of Advanced Pulse Induction.

The Infinium LS requires no complicated adjusting. When hunting in consistent soil, Automatic Ground Track

allows "locking" the ground track for optimum performance, or selecting "slow" or "fast" automatic tracking depending on the changes in soil composition.

The Audio Threshold adjustment control is designed to suit individual hunting styles and listening needs for clear audible interpretation of target signals. The operating frequency of the detector may be adjusted to minimize electrical interference.

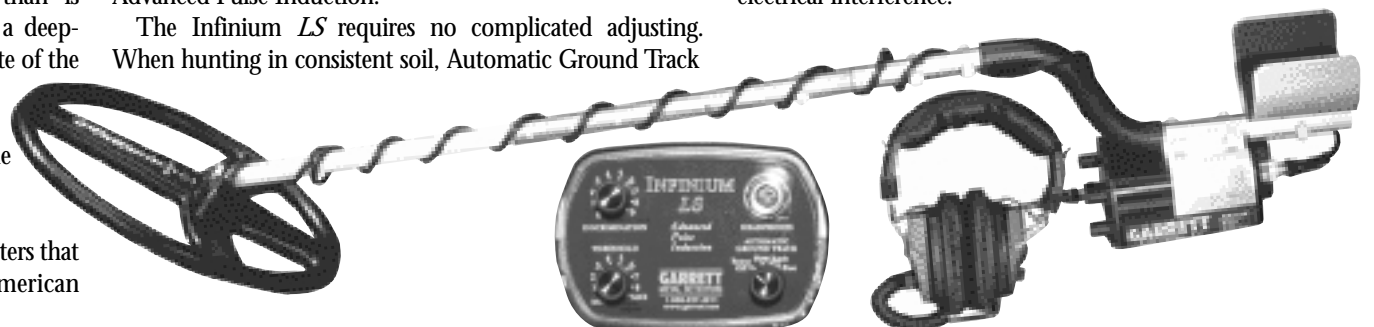



# SEARCH INTERNATIONAL

1881 W. State Street  
Garland, Texas 75042-6797 U.S.A.  
1-800-527-4011  
Email: sales@garrett.com

Metal Detectors  
Lowest Prices  
www.detection.com  
1-800-301-6151

PRSR STD  
U.S. Postage  
**PAID**  
Permit No. 179  
Garland, TX  
75040

Return Service Requested

## *We Need Your New Address*

To make sure you don't miss any exciting issues of the *SEARCHER*, we need your help.

If you have moved or are planning to move, give us your new address ASAP by calling 1-800-527-4011.

You may also want to include your email address so that you can automatically receive updates when available on Garrett products, services and events.

Publisher .....Charles Garrett  
Editor .....Hal Dawson  
Feature Writer .....Rhonda Chirafisi  
Layout/Design.....Ron Kerns

Metal Detectors  
Lowest Prices  
www.detection.com  
1-800-301-6151

Published by  
Garrett Metal Detectors  
1881 West State Street  
Garland, TX 75042-6797 U.S.A.  
1-800-527-4011  
sales@garrett.com

Visit us on the web at  
www.garrett.com

© 2002 Garrett Metal Detectors



### **FREE World Bible Study Correspondence Course**

Write: Search International  
1881 W. State Street  
Garland, TX 75042

Issue Number 36

October 2002

PN 3500036